



浙江万享科技股份有限公司
Zhejiang Wanxiang Technology Corp.

Zhejiang Wanxiang Technology Corp.

No 799, Changxing Avenue, Taihu Street, Changxing County, Huzhou City, Zhejiang Province, China

TEL: 86 0572-6557590

FAX: 86 0572-6556555

URL: <http://www.wanxiang.cc>

MAIL: info@wanxiang.cc



FBH/FBHL Closed Mixed Flow, Induced-draft Cooling Tower

Design Information

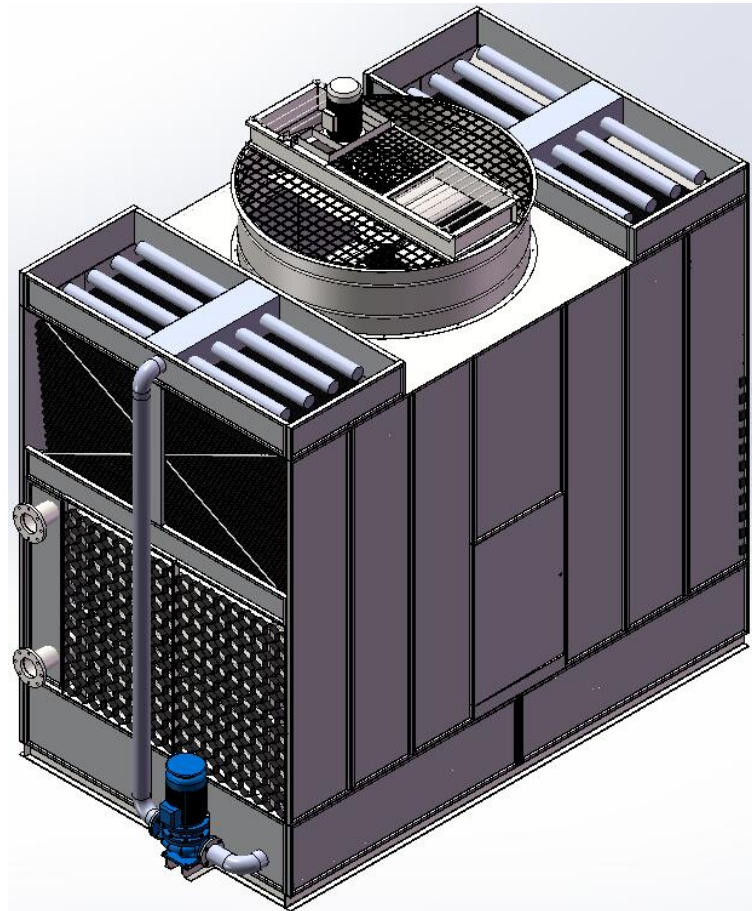

I. Outline of models

(closed type, Mixed Flow, and induced draft)

Models	Cooling capacity (37-32-28 °C)	Inlet and outlet pipe Diameter of host machine	Water rate	Spray pump			Fan		Outline dimension			Weight of host machine	Operating weight
				Inlet-Outlet Diameter,	Impeller Size,	Motor Size	Power	Diameter	Length	Width	Height		
	KCAL	mm	(m ³ /h)	mm	mm	kW/ Poles	(KW)	(mm)	mm	mm	mm	(kg)	(kg)
FBH-012ED	90000	DN100	18	80	Φ98	1.1/2	2.2	1100	1528	2250	4150	1300	2200
FBH-012EG	100000	DN100	20	80	Φ98	1.1/2	3	1100	1528	2250	4150	1325	2220
FBH-013ED	110000	DN100	22	80	Φ98	1.1/2	3	1100	1528	2250	4150	1350	2250
FBH-013EG	120000	DN100	24	80	Φ98	1.1/2	4	1100	1528	2250	4150	1380	2300
FBH-062ED	140000	DN100	28	80	Φ115	1.5/2	3	1200	1850	2610	4150	2000	3330
FBH-062EG	155000	DN100	31	80	Φ115	1.5/2	4	1200	1850	2610	4150	2025	3350
FBH-063ED	160000	DN100	32	80	Φ115	1.5/2	4	1200	1850	2610	4150	2100	3450
FBH-063EG	175000	DN100	35	80	Φ115	1.5/2	5.5	1200	1850	2610	4150	2125	3490
FBH-132ED	165000	DN100	33	80	Φ130	2.2/2	4	1300	1850	2896	4150	2200	3500
FBH-132EG	180000	DN100	36	80	Φ130	2.2/2	5.5	1300	1850	2896	4150	2225	3525
FBH-133ED	195000	DN100	39	80	Φ130	2.2/2	5.5	1300	1850	2896	4150	2420	3650
FBH-133EG	215000	DN100	43	80	Φ130	2.2/2	7.5	1300	1850	2896	4150	2450	3690
FBH-153ED	345000	DN100	69	100	Φ130	2.2/2	5.5	1800	2250	3540	4150	3150	5460
FBH-153EG	380000	DN100	76	100	Φ130	2.2/2	7.5	1800	2250	3540	4150	3260	5570
FBH-154HD	420000	DN100	84	100	Φ145	3.0/2	7.5	1800	2250	3540	4980	3680	6050
FBH-154HG	475000	DN100	95	100	Φ145	3.0/2	11	1800	2250	3540	4980	3750	6120
FBHL-341BD	205000	DN100	41	80	Φ98	1.1/2	4	1600	2250	3792	3550	2300	4650
FBHL-342BD	225000	DN100	45	80	Φ98	1.1/2	4	1600	2250	3792	3550	2450	4800
FBHL-342ED	255000	DN100	51	80	Φ98	1.1/2	4	1600	2250	3792	4150	3000	5300
FBHL-342EP	275000	DN100	58	80	Φ98	1.1/2	5.5	1600	2250	3792	4150	3060	5360
FBHL-343EP	320000	DN100	64	80	Φ98	1.1/2	5.5	1600	2250	3792	4150	3300	5650
FBHL-343EL	355000	DN100	71	80	Φ98	1.1/2	7.5	1600	2250	3792	4150	3350	5700



FBHL-361BD	330000	DN100	66	80	Φ115	1.5/2	5.5	2200	2476	4792	3550	3800	7050
FBHL-362BP	385000	DN100	77	80	Φ115	1.5/2	7.5	2200	2476	4792	3550	3980	7100
FBHL-362ED	415000	DN125	83	80	Φ115	1.5/2	7.5	2200	2476	4792	4150	4350	7600
FBHL-362EP	445000	DN125	95	80	Φ115	1.5/2	11	2200	2476	4792	4150	4400	7650
FBHL-363ED	485000	DN125	94	80	Φ115	1.5/2	7.5	2200	2476	4792	4150	4500	7800
FBHL-363EP	510000	DN125	102	80	Φ115	1.5/2	11	2200	2476	4792	4150	4580	7850
FBHL-363HP	530000	DN125	106	80	Φ115	1.5/2	11	2200	2476	4792	4980	4900	8100
FBHL-363HG	575000	DN125	118	80	Φ115	1.5/2	15	2200	2476	4792	4980	4980	8200
FBHL-364HP	630000	DN125	126	80	Φ115	1.5/2	11	2200	2476	4792	4980	5100	8600
FBHL-364HG	665000	DN125	141	80	Φ115	1.5/2	15	2200	2476	4792	4980	5180	8700
FBHL-381BD	460000	DN125	92	100	Φ130	2.2/4	7.5	2600	2976	5220	3550	4500	8430
FBHL-382BP	520000	DN125	104	100	Φ130	2.2/4	11	2600	2976	5220	3550	4700	8500
FBHL-382ED	560000	DN125	112	100	Φ130	2.2/4	11	2600	2976	5220	4150	5220	9120
FBHL-382EP	620000	DN125	124	100	Φ130	2.2/4	15	2600	2976	5220	4150	5300	9200
FBHL-383ED	610000	DN125	122	100	Φ130	2.2/4	11	2600	2976	5220	4150	5500	9500
FBHL-383EP	675000	DN125	135	100	Φ130	2.2/4	15	2600	2976	5220	4150	5550	9550
FBHL-383HP	745000	DN125	150	100	Φ130	2.2/4	15	2600	2976	5220	4980	6050	10050
FBHL-383HG	800000	DN125	160	100	Φ130	2.2/4	18.5	2600	2976	5220	4980	6100	10100
FBHL-384HD	805000	DN125	161	100	Φ130	2.2/4	15	2600	2976	5220	4980	6500	10700
FBHL-384HP	865000	DN125	173	100	Φ130	2.2/4	18.5	2600	2976	5220	4980	6580	10800
FBHL-384HG	925000	DN125	184	100	Φ130	2.2/4	22	2600	2976	5220	4980	6650	10850
FBHL-393ED	1325000	DN150	221	100	Φ145	3/4	18.5	3200	3620	6396	4150	7450	12300
FBHL-393EP	1425000	DN150	235	100	Φ145	3/4	22	3200	3620	6396	4150	7500	12380
FBHL-393EG	1585000	DN150	260	100	Φ145	3/4	30	3200	3620	6396	4150	7630	12500
FBHL-393HD	1460000	DN150	245	100	Φ145	3/4	22	3200	3620	6396	4980	8300	13180
FBHL-393HP	1625000	DN150	270	100	Φ145	3/4	30	3200	3620	6396	4980	8420	13300
FBHL-393HG	1740000	DN150	290	100	Φ145	3/4	37	3200	3620	6396	4980	8550	13430
FBHL-394HD	1650000	DN150	275	100	Φ145	3/4	30	3200	3620	6396	4980	8720	13750
FBHL-394HP	1855000	DN150	295	100	Φ145	3/4	37	3200	3620	6396	4980	8850	13900
FBHL-394HG	2000000	DN150	314	100	Φ145	3/4	45	3200	3620	6396	4980	9000	14100



FBHL-413ED	1300000	DN150	271	150	Φ185	5.5/4	18.5	3400	3620	7316	5020	15550	22400
FBHL-413EL	1370000	DN150	288	150	Φ185	5.5/4	22	3400	3620	7316	5020	15650	22500
FBHL-413EP	1480000	DN150	320	150	Φ185	5.5/4	30	3400	3620	7316	5020	15800	22650
FBHL-413EG	1570000	DN150	343	150	Φ185	5.5/4	37	3400	3620	7316	5020	15950	22800
FBHL-413HD	1445000	DN200	305	150	Φ185	5.5/4	22	3400	3620	7316	6050	16200	23050
FBHL-413HL	1570000	DN200	339	150	Φ185	5.5/4	30	3400	3620	7316	6050	16350	23200
FBHL-413HP	1675000	DN200	360	150	Φ185	5.5/4	37	3400	3620	7316	6050	16500	23350
FBHL-413HG	1760000	DN200	385	150	Φ185	5.5/4	45	3400	3620	7316	6050	16650	23500
FBHL-414HD	1685000	DN200	363	150	Φ185	5.5/4	30	3400	3620	7316	6050	17550	24950
FBHL-414HL	1800000	DN200	389	150	Φ185	5.5/4	37	3400	3620	7316	6050	17700	25100
FBHL-414HP	1895000	DN200	415	150	Φ185	5.5/4	45	3400	3620	7316	6050	17850	25250
FBHL-414HG	2030000	DN200	444	150	Φ185	5.5/4	55	3400	4250	7960	6050	18050	25450
FBHL-433ED	1660000	DN150	337	150	Φ185	5.5/4	22	3900	4250	7960	5020	17670	25240
FBHL-433EL	1775000	DN150	375	150	Φ185	5.5/4	30	3900	4250	7960	5020	17830	25400
FBHL-433EP	1880000	DN150	402	150	Φ185	5.5/4	37	3900	4250	7960	5020	17970	25540
FBHL-433EG	1965000	DN150	428	150	Φ185	5.5/4	45	3900	4250	7960	5020	18130	25700
FBHL-433HD	1870000	DN200	397	150	Φ185	5.5/4	30	3900	4250	7960	6050	18440	26000
FBHL-433HL	1980000	DN200	425	150	Φ185	5.5/4	37	3900	4250	7960	6050	18580	26140
FBHL-433HP	2080000	DN200	454	150	Φ185	5.5/4	45	3900	4250	7960	6050	18740	26300
FBHL-433HG	2190000	DN200	485	150	Φ185	5.5/4	55	3900	4250	7960	6050	18940	26500
FBHL-434HD	2000000	DN200	425	150	Φ185	5.5/4	30	3900	4250	7960	6050	19950	28120
FBHL-434HL	2120000	DN200	456	150	Φ185	5.5/4	37	3900	4250	7960	6050	20100	28270
FBHL-434HP	2230000	DN200	480	150	Φ185	5.5/4	45	3900	4250	7960	6050	20260	28430
FBHL-434HG	2365000	DN200	510	150	Φ185	5.5/4	55	3900	4250	7960	6050	20460	28630

* Significance of the model names:

F	B	H/HL	-	062E	D
Induced Draft	Closed Cooling Tower	Mixed Flow		Unit Model	Fan code



II. Drawings:

1) Model FBH-012(ED/EG)

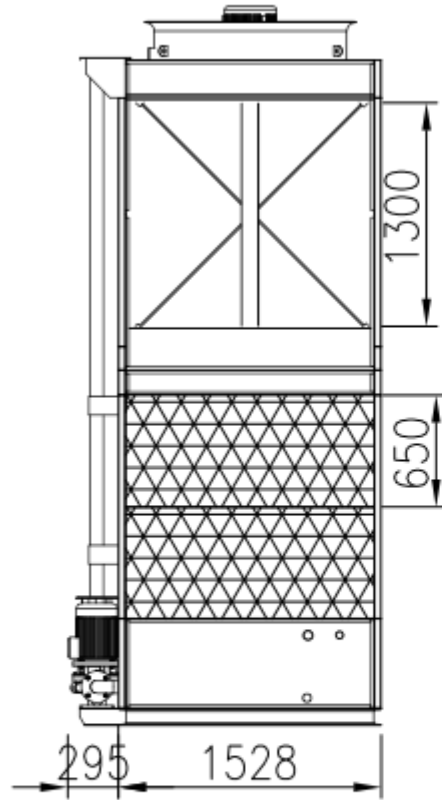

VIEW 2

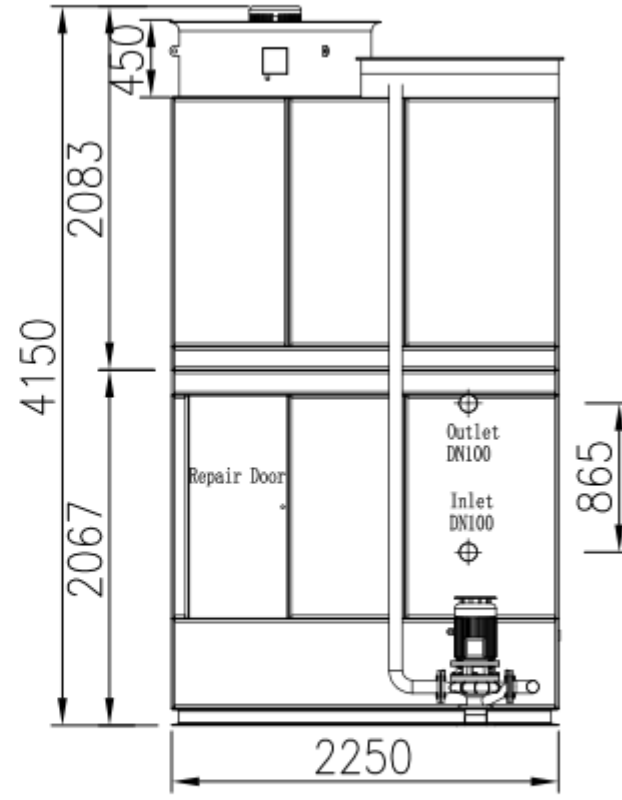

VIEW 1



2) Model FBH-013(ED/EG)

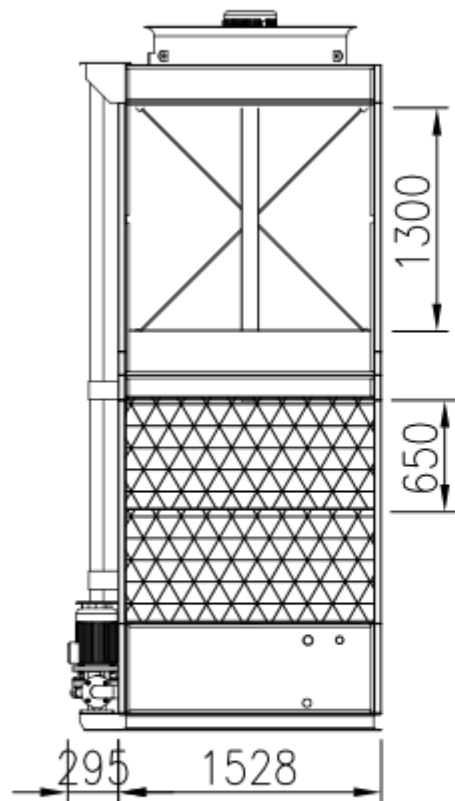

VIEW 2

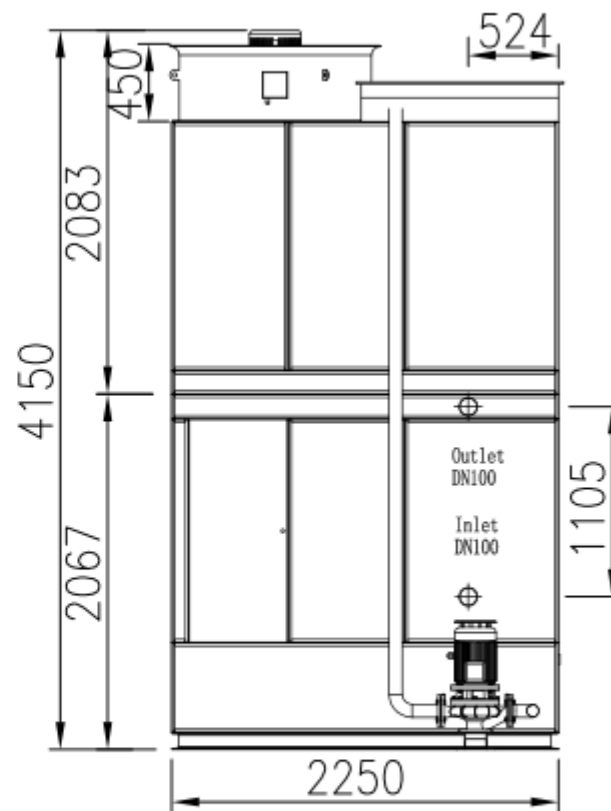

VIEW 1



3) Model FBH-062(ED/EG)

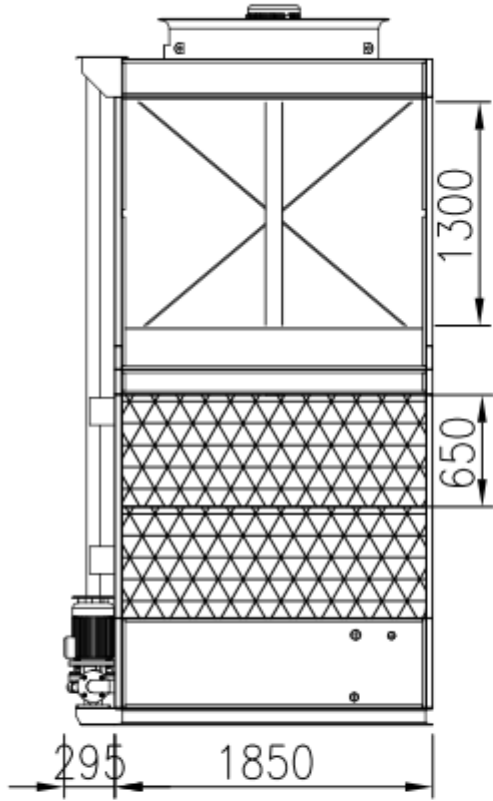

VIEW 2

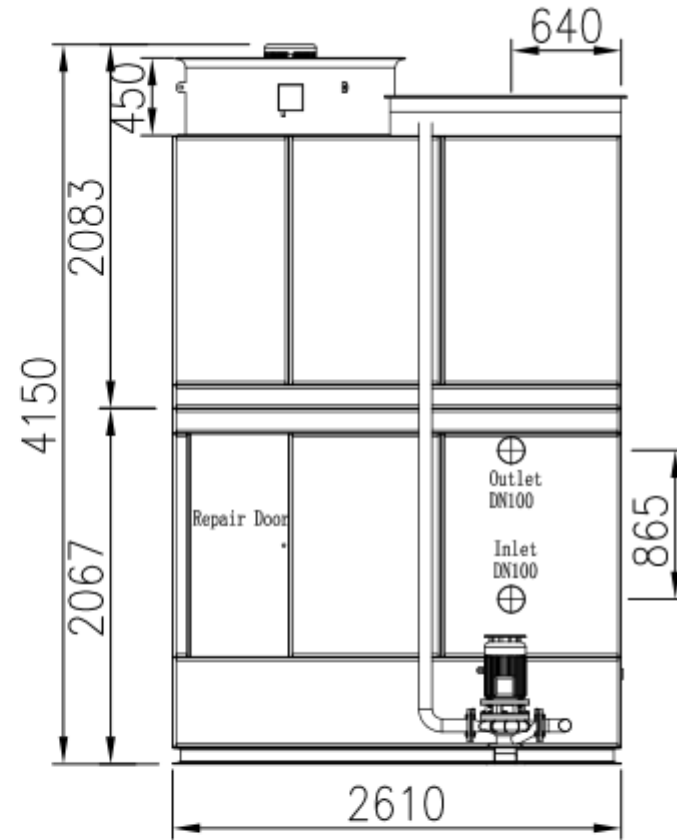

VIEW 1



4) Model FBH-063(ED/EG)

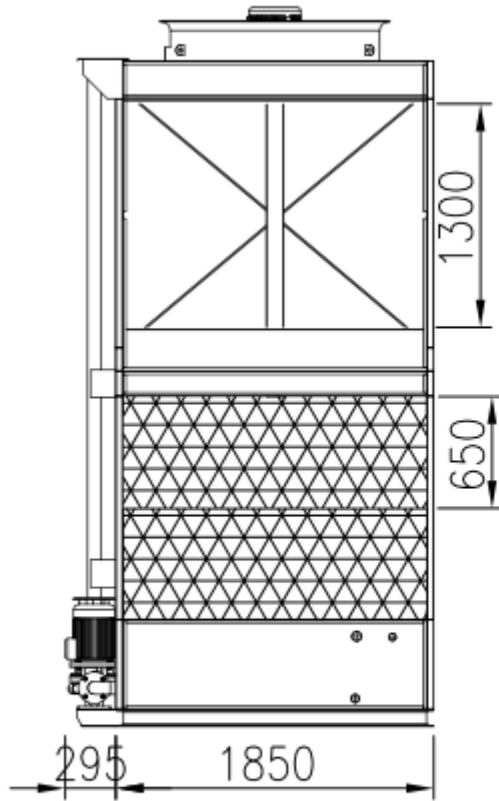

VIEW 2

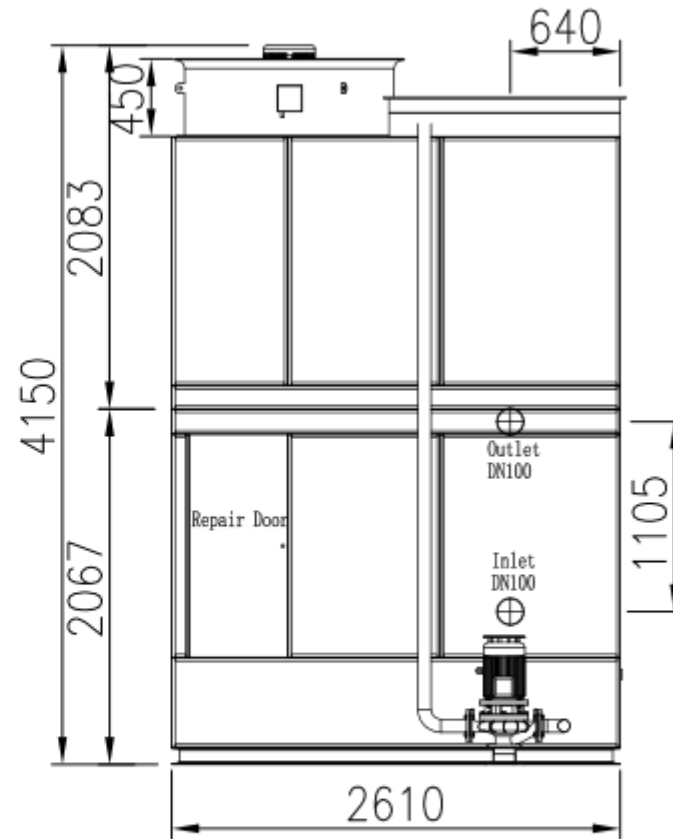

VIEW 1



5) Model FBH-132(ED/EG)

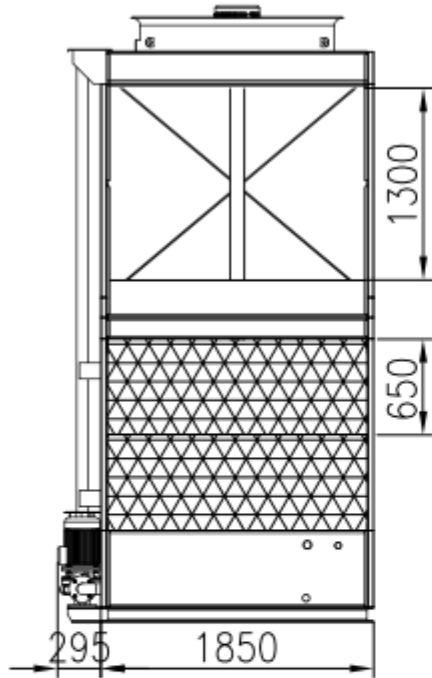

VIEW 2

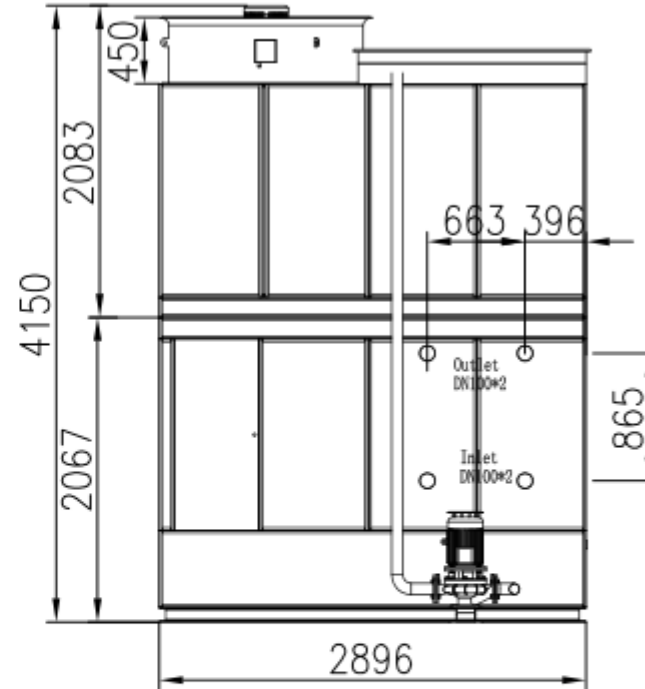

VIEW 1



6) Model FBH-133(ED/EG)

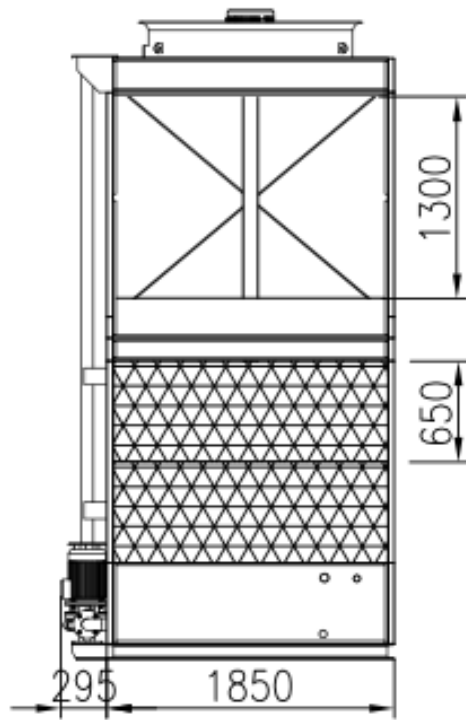

VIEW 2

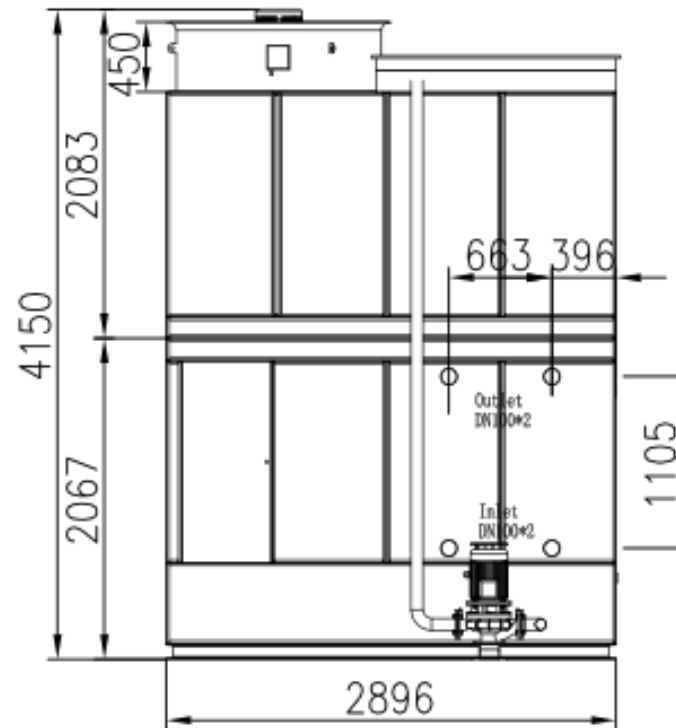

VIEW 1



6) Model FBH-153(ED/EG)

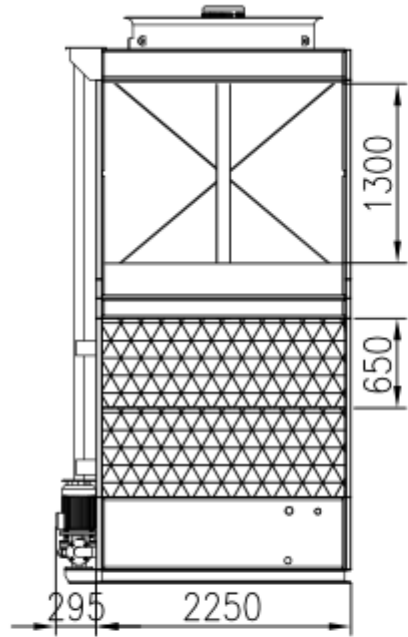

VIEW 2

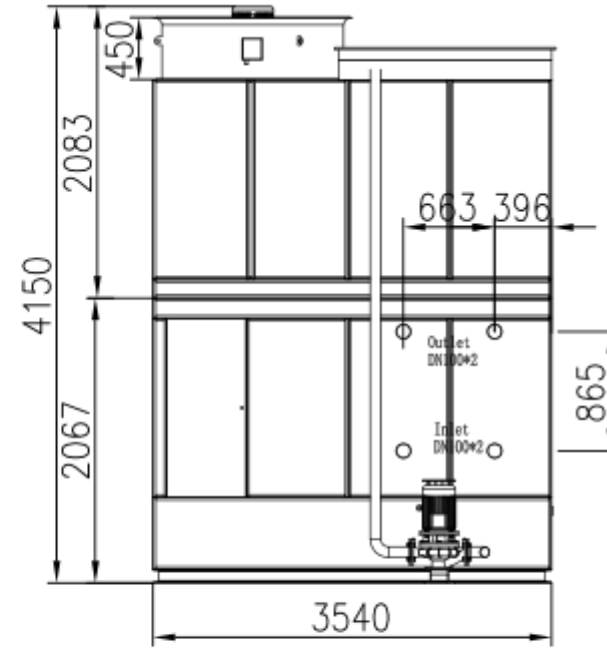

VIEW 1



6) Model FBH-154(HD/HG)

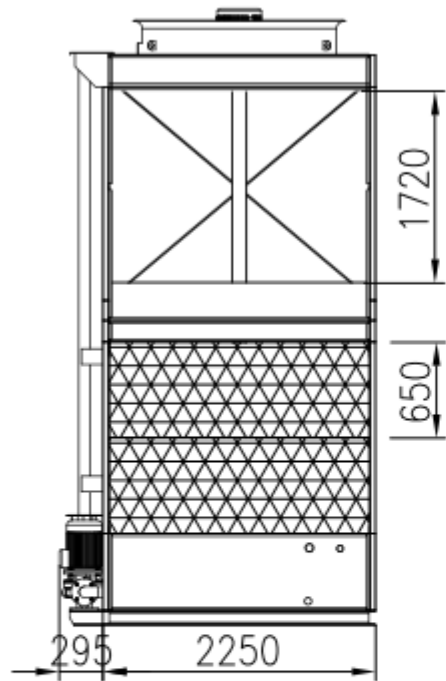

VIEW 2

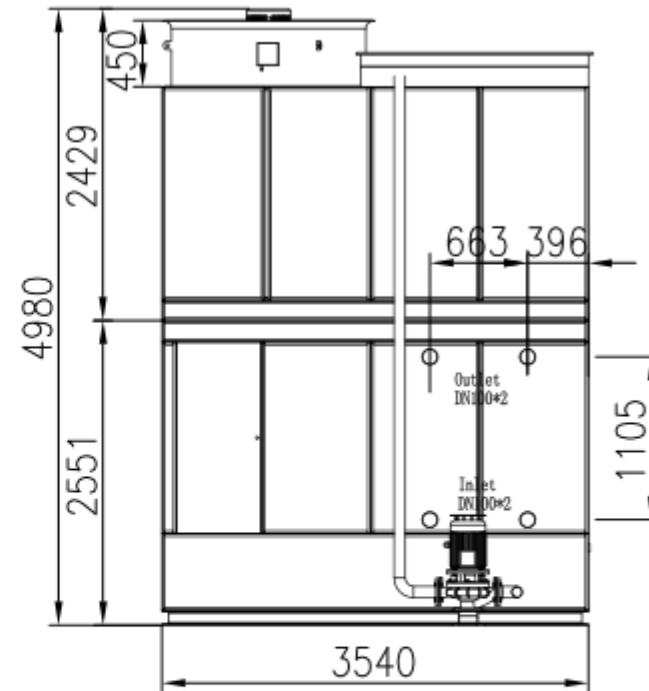

VIEW 1



7) Model FBHL-34X

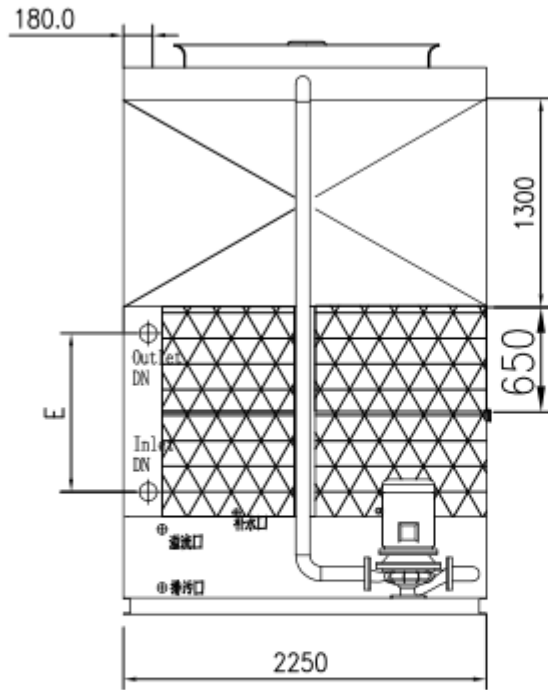

VIEW 2

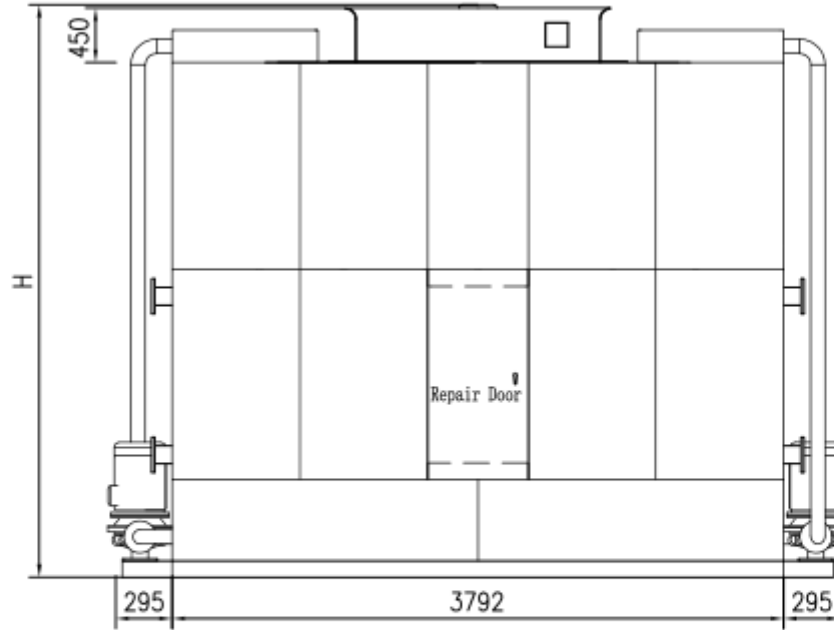

VIEW 1

型号	H	E	DN
FBHL-341BD	3550	625	100x2
FBHL-342BD	3550	865	100x2
FBHL-342ED	4150	865	100x2
FBHL-342EP	4150	865	100x2
FBHL-343EP	4150	1105	100x2
FBHL-343EL	4150	1105	100x2



8) Model FBHL-36X

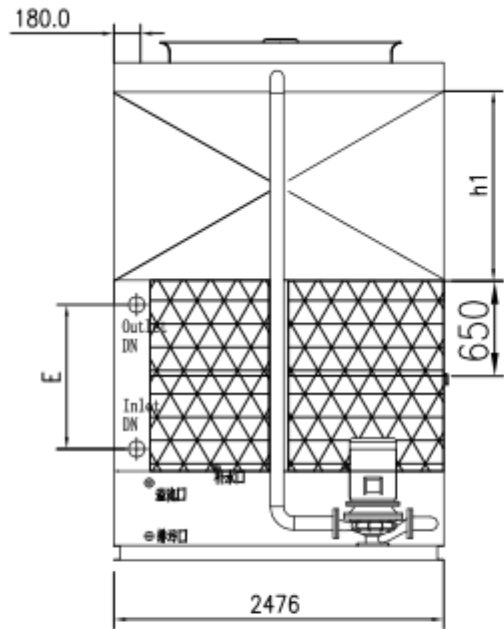

VIEW 2

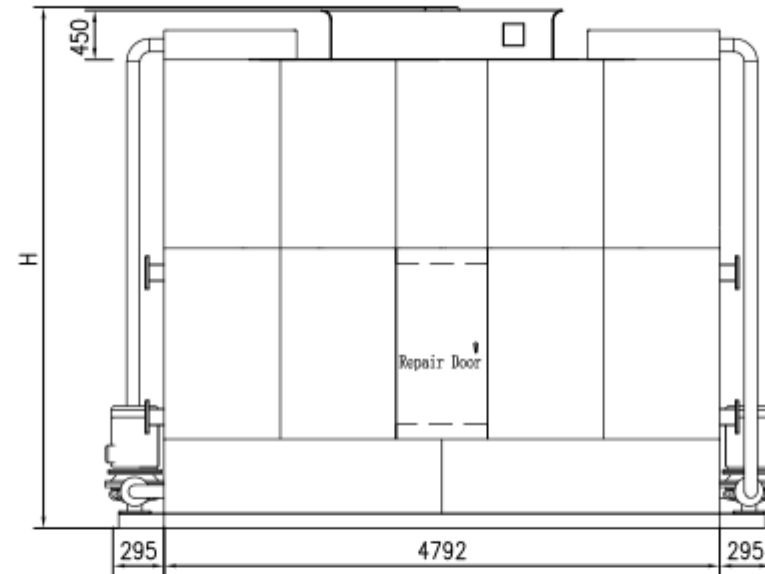

VIEW 1

型号	H	E	DN	h1
FBHL-361BD	3550	625	100x2	1300
FBHL-362BP	3550	865	100x2	1300
FBHL-362ED	4150	865	125x2	1300
FBHL-362EP	4150	865	125x2	1300
FBHL-363ED	4150	1105	125x2	1300
FBHL-363EP	4150	1105	125x2	1300
FBHL-363HP	4980	1105	125x2	1720
FBHL-363HG	4980	1105	125x2	1720
FBHL-364HP	4980	1345	125x2	1720
FBHL-364HG	4980	1345	125x2	1720



9) Model FBHL-38X

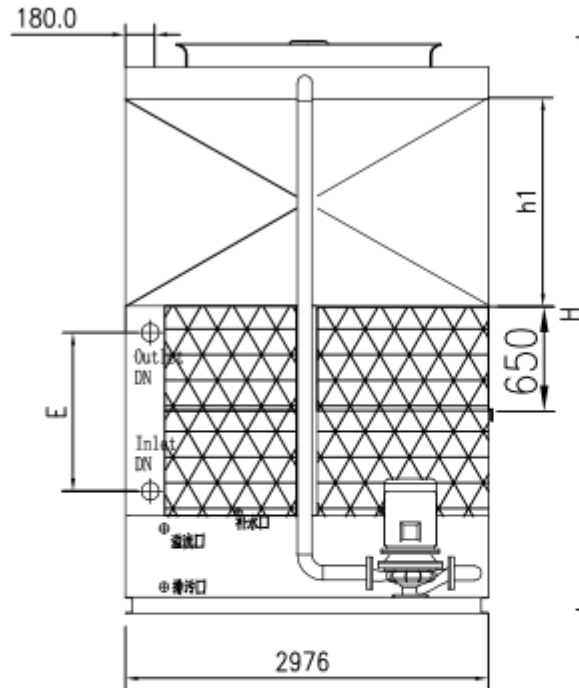

VIEW 2

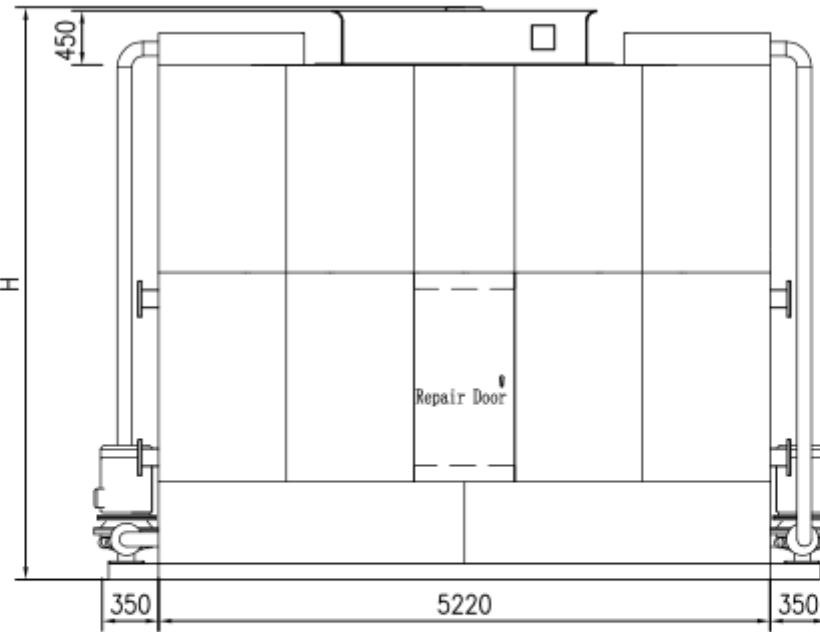

VIEW 1

型号	H	E	DN	h1
FBHL-381BD	3550	625	125x2	1300
FBHL-382BP	3550	865	125x2	1300
FBHL-382ED	4150	865	125x2	1300
FBHL-382EP	4150	865	125x2	1300
FBHL-383ED	4150	1105	125x2	1300
FBHL-383EP	4150	1105	125x2	1300
FBHL-383HP	4980	1105	125x2	1720
FBHL-383HG	4980	1105	125x2	1720
FBHL-384HD	4980	1345	125x2	1720
FBHL-384HP	4980	1345	125x2	1720
FBHL-384HG	4980	1345	125x2	1720



10) Model FBHL-39X

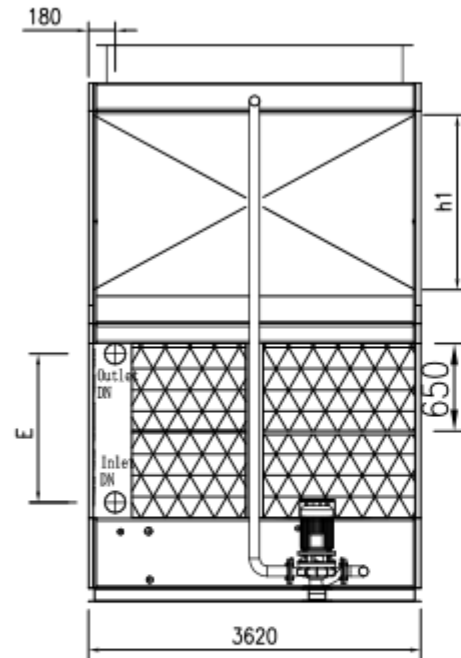

VIEW 2

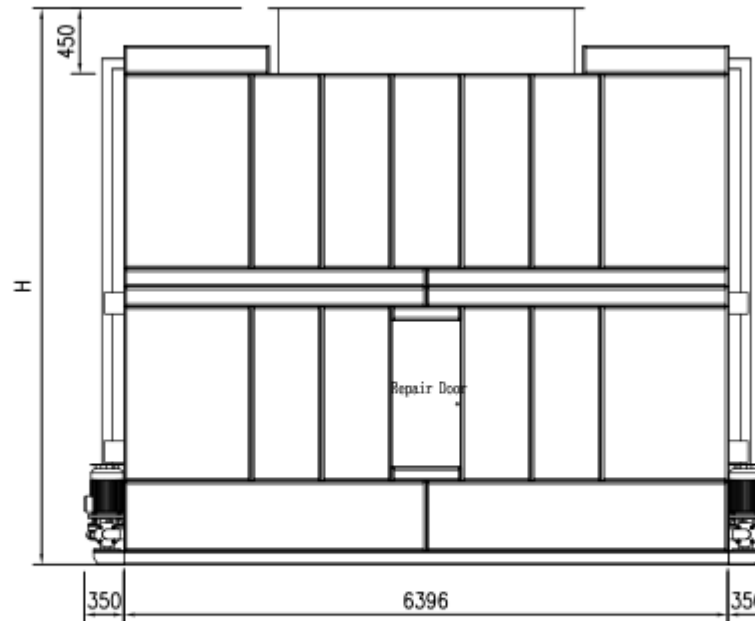

VIEW 1

型号	H	E	DN	h1
FBHL-393ED	4150	1105	150x2	1300
FBHL-393EP	4150	1105	150x2	1300
FBHL-393EG	4150	1105	150x2	1300
FBHL-393HD	4980	1105	150x2	1720
FBHL-393HP	4980	1105	150x2	1720
FBHL-393HG	4980	1105	150x2	1720
FBHL-394HD	4980	1345	150x2	1720
FBHL-394HP	4980	1345	150x2	1720
FBHL-394HG	4980	1345	150x2	1720



11) Model FBHL-41X

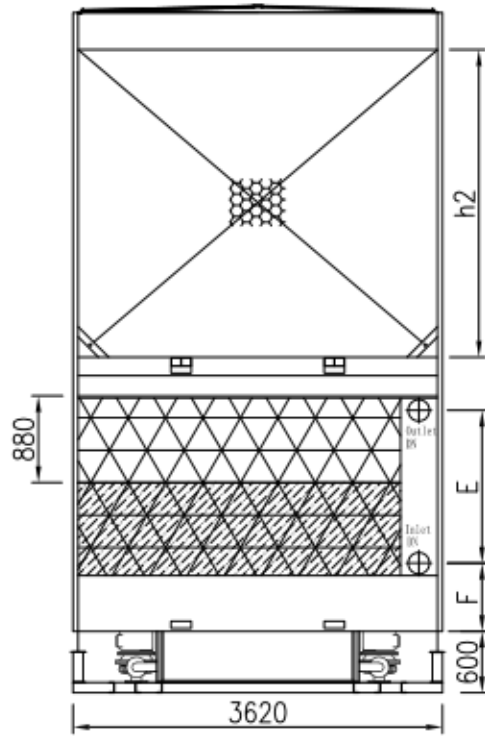

VIEW 2

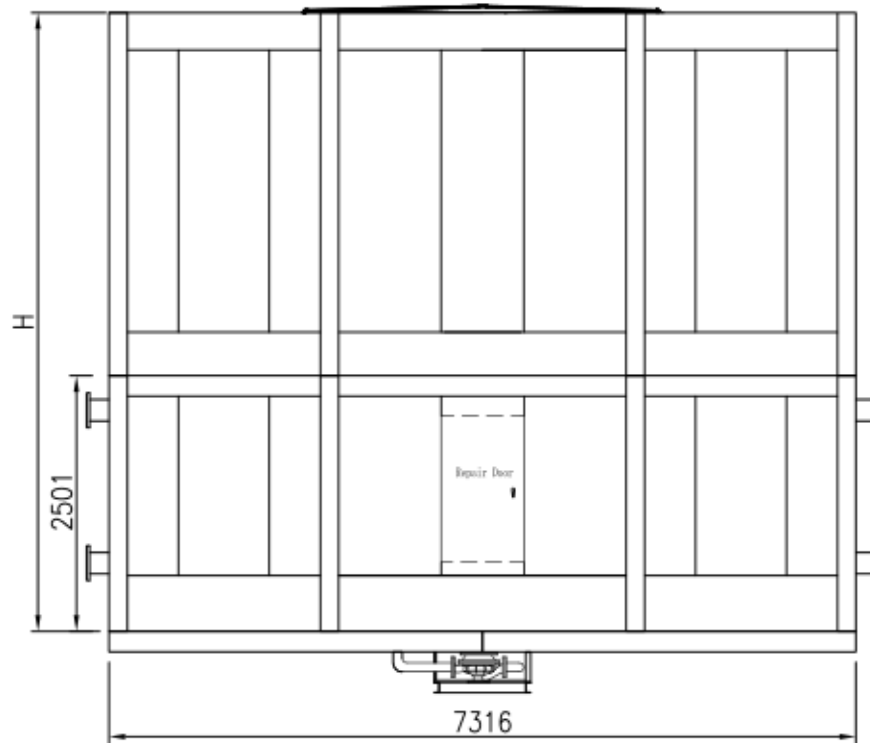

VIEW 1

型号	H	E	F	DN	h2
FBHL-413ED	5020	1235	797	150x2	1974
FBHL-413EL	5020	1235	797	150x2	1974
FBHL-413EP	5020	1235	797	150x2	1974
FBHL-413EG	5020	1235	797	150x2	1974
FBHL-413HD	6050	1235	797	200x2	3004
FBHL-413HL	6050	1235	797	200x2	3004
FBHL-413HP	6050	1235	797	200x2	3004
FBHL-413HG	6050	1235	797	200x2	3004
FBHL-414HD	6050	1495	667	200x2	3004
FBHL-414HL	6050	1495	667	200x2	3004
FBHL-414HP	6050	1495	667	200x2	3004
FBHL-414HG	6050	1495	667	200x2	3004



12) Model FBHL-43X

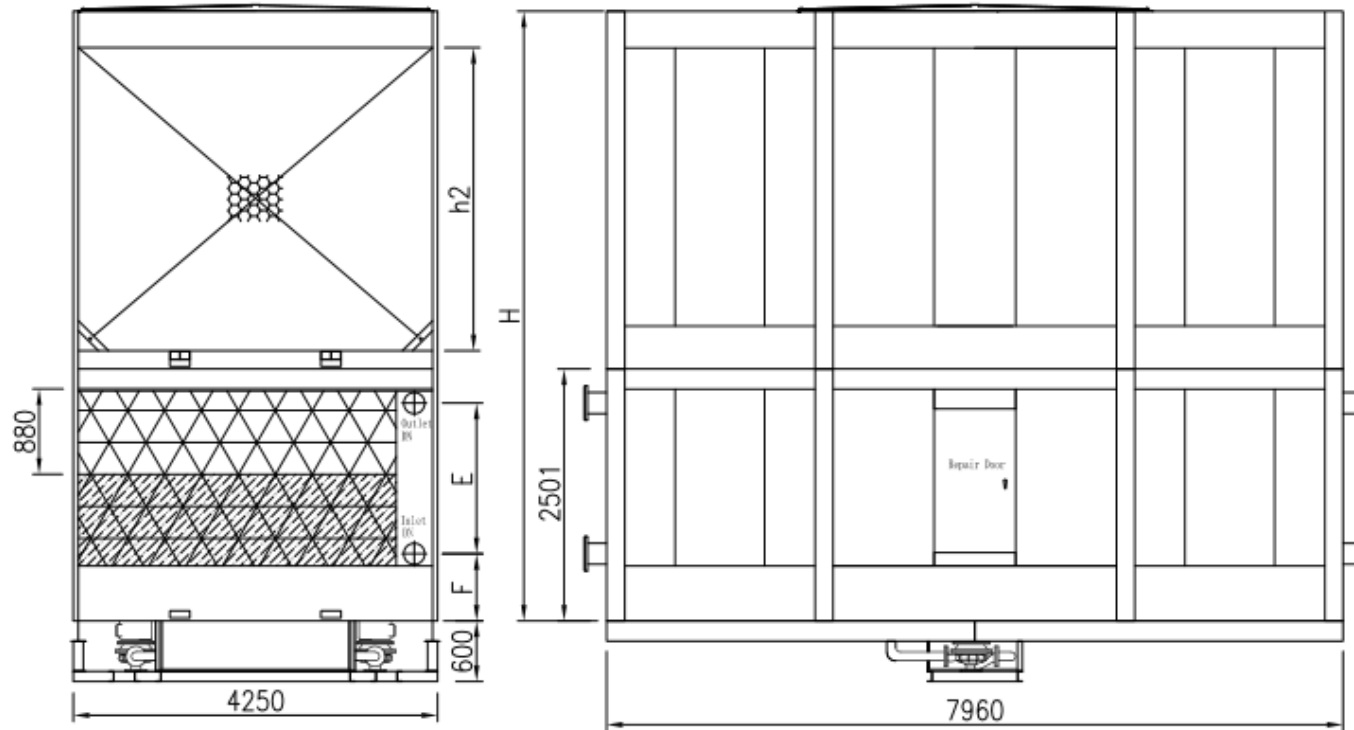

VIEW 2

VIEW 1

型号	H	E	F	DN	h2
FBHL-433ED	5020	1235	797	150x2	1974
FBHL-433EL	5020	1235	797	150x2	1974
FBHL-433EP	5020	1235	797	150x2	1974
FBHL-433EG	5020	1235	797	150x2	1974
FBHL-433HD	6050	1235	797	200x2	3004
FBHL-433HL	6050	1235	797	200x2	3004
FBHL-433HP	6050	1235	797	200x2	3004
FBHL-433HG	6050	1235	797	200x2	3004
FBHL-434HD	6050	1495	667	200x2	3004
FBHL-434HL	6050	1495	667	200x2	3004
FBHL-434HP	6050	1495	667	200x2	3004
FBHL-434HG	6050	1495	667	200x2	3004